

# WARNING:

Before putting tool in service,  
take to your immediate  
supervisor.

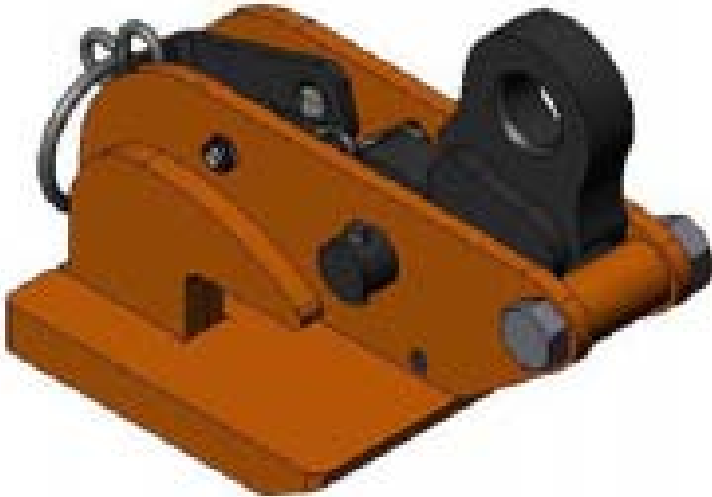

# RENFROE



Application, Operation and Maintenance Manual  
Model DWS

OM 211-DWS



# Operators Manual

This Operator's Manual covers the Application, Operation and Maintenance of this RENFROE product. Operator's Manuals for other current RENFROE products are available upon request. Direct Requests to J.C. Renfroe & Sons, Inc., Jacksonville, Florida 32201.

**J.C. RENFROE & SONS,  
INCORPORATED**

of Jacksonville, Florida, has been an international leader in the manufacture and marketing of Lifting Clamps for over fifty years. **RENFROE** products are manufactured in Jacksonville, Florida. A worldwide network of stocking distributors provides a readily available source of supply and service.

**J.C. RENFROE & SONS, IN-  
CORPORATED**

Jacksonville, Florida 32201  
Telephone: 904/356-4181  
Toll Free: 1-800-874-8454  
Fax: 904/354-7865  
*www.jcrenfroe.com*

---

THIS PUBLICATION SUPERSEDES ALL PREVIOUSLY PUBLISHED AND/OR DISTRIBUTED INFORMATION BY MANUFACTURER AND/OR ITS DISTRIBUTORS WITH RESPECT TO APPLICABLE RENFROE PRODUCTS AND SUBJECT MATTER DESCRIBED OR CONTAINED HEREIN.

---

### **WARNING:**

Prior to selection, operation and/or maintenance of RENFROE products, read and understand the information provided in this manual.

The understanding and use of the Definitions are important in determining the limitations and proper application of RENFROE products.

Failure to review and utilize recommended applications, operation and maintenance instructions may result in serious injury to operator and others.

---

#### **NOTICE OF EXCLUSION OF WARRANTY**

**RENFROE HAS HEREIN SET FORTH IN CONSPICUOUS LANGUAGE AN EXCLUSION OF ANY WARRANTY EITHER EXPRESSED OR IMPLIED, WHICH IS NOT SPECIFICALLY AND PARTICULARLY CONTAINED HEREIN. PLEASE REFER TO THAT STATEMENT FOR REPRESENTATIONS AND WARRANTIES OF PRODUCTS MANUFACTURED BY J.C. RENFROE & SONS, INC.**

# OPERATING AIDS

## (DO'S AND DON'TS)

1. DO read and understand the operator's manual before using clamp.
2. DO consult Operator's Manual or RENFROE when in doubt.
3. DON'T lift over workmen. DON'T lift over safety areas or personnel.
4. DO attend a factory training class for establishing proper use of Renfro Products.
5. DO Lock clamp closed when clamps are fitted with a lock. DON'T lift with lock in open or "lock open" position.
6. DON'T use a connection that may release the clamp.
7. DON'T attach clamp directly to crane hook. DO use a flexible connection between crane hook and clamp shackle. DON'T use heavy flexible connection.
8. DO use correct clamp for job. DON'T use large capacity clamps to lift light loads.
9. DO use an adequate number of clamps to balance load. DON'T lift loads that are not balanced.
10. DO use clamps within their rated capacity. DON'T overload clamps.
11. Do inspect clamp before each lift, follow inspection and maintenance instructions outlined in the manual and use RENFROE replacement parts to assure proper operation of the clamp.
12. DON'T use clamp that has been overloaded. DO refer to pre-lift inspection in Operator's Manual.
13. DON'T side load with a straight shackle clamp.
14. DON'T misuse. DON'T lift plate from bottom of plate stack.
15. DON'T rush. DON'T lift more than one plate at a time with a vertical clamp.
16. DON'T improvise. Always use correct clamp for the job. DON'T lift plate horizontally with a vertical lift only clamp.
17. DON'T alter clamp. DON'T grind, weld or modify the clamp in any manner.

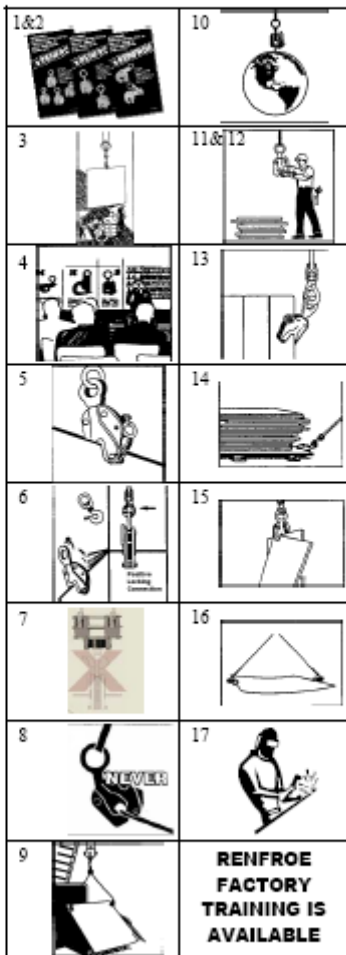

**J.C. RENFROE & SONS, INC.**  
P.O. BOX 4279 / 1926 SPEARING STREET / JACKSONVILLE, FL. 32201

Phone: 904-356-4181  
Facsimile: 904-354-7965  
Internet: [www.jorenfro.com](http://www.jorenfro.com)  
E-Mail: [sales@jorenfro.com](mailto:sales@jorenfro.com)

---

# OPERATING AIDS

## (DO'S AND DON'TS)

---

1. DO read and understand the Operators Manual before using the clamp
2. DO Consult Operator's Manual or RENFROE when in doubt.
3. DON'T Lift over workmen DON'T lift over Safety Areas or personnel.
4. Do attend a factory training class for establishing proper use of Renfro Products.
5. DO Lock clamp closed before lifting load. DON'T lift with lock in open or "Lock Open" position.
6. DON'T Use a connection that may release the clamp.
7. DON'T attach clamp directly to crane hook. DO use a flexible connection between crane and clamp shackle. DON'T use heavy flexible connection.
8. DO use correct clamp for job. DON'T use large capacity clamps to lift light loads.
9. DO Use an adequate number of clamps to balance load. DON'T lift loads that are not balanced.
10. DO Use clamps within their rated capacity. DON'T overload clamps
11. DO Inspect clamp before each lift, follow inspection and maintenance instructions outlined in this manual and use RENFROE replacement parts to assure proper operation of the clamp
12. DON'T Use clamp that has been overloaded. DO refer to pre-lift inspection in Operators Manual
13. DON'T Side load with a straight shackle clamp. DON'T lift from side with vertical clamp
14. DON'T Misuse. DON'T lift plate from bottom of plate stack.
15. DON'T Rush. DON'T lift more than one plate at a time with a vertical clamp.
16. DON'T Improvise. Always use correct clamp for job. DON'T lift plate horizontally with a vertical lift only clamp.
17. DON'T Alter clamp. DON'T grind, weld or modify the clamp in any manner.

# DEFINITIONS

**VERTICAL LIFT:** The lifting of a single plate or member in which the lifting force exerted by the rigging is directly above and in line with the lifting shackle as shown in the illustration below.

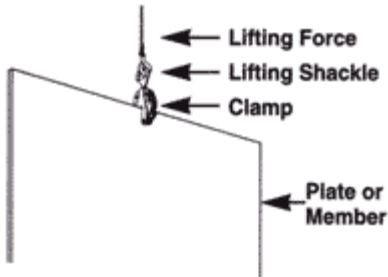

**VERTICAL TURN/LIFT:** A vertical turn/lift clamp is a vertical lifting clamp specifically intended to turn a single plate or member thru a ninety degree ( $90^\circ$ ) arc and back to vertical thru the same ninety degree ( $90^\circ$ ) arc or from horizontal to vertical to horizontal thru a one hundred and eighty degree ( $180^\circ$ ) arc. Refer to Application Section of specific Turn/Lift clamps for further detail. During the turning operation the edge of the plate opposite the edge to which the clamp is attached should always be in contact with a supporting surface such as a factory floor and the load on the clamp not exceed one half rated capacity of clamp—refer to illustrations shown below.

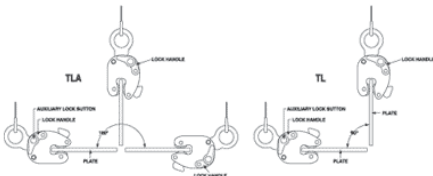

**HORIZONTAL LIFT:** Clamps (used in pairs or multiples) are attached to the side edges of a plate or bundle of plates positioned horizontally to the floor level. The rigging attached to clamps is generally multi-legged slings with the connecting point of the slings being approximately centered between the distance separating the clamps. Refer to illustrations shown below. **WARNING:** The capacity of all horizontal clamps is based on a sling angle of sixty degrees ( $60^\circ$ ). See illustration below. Sling angles less than sixty degrees ( $60^\circ$ ) increase the load exerted on the clamps, Never exceed the rated capacity of a single clamp.

**STEEL PLATES:** Unless otherwise

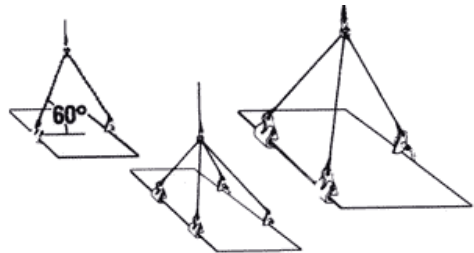

specified, lifting clamps are manufactured to handle hot-rolled steel plates whose Brinell Hardness does not exceed 300. **WARNING:** Do not lift plates with coatings or mill scale that prevent the gripping surfaces of the clamp from making positive contact with the base metal.

For applications not covered by the above information, secure written recommendations from RENFROE.

**FINISHED AND POLISHED PLATES:** Steel plates in this category have other than hot-rolled surfaces such as stainless steel, etc., are generally handled using non-marring clamps incorporating smooth gripping surfaces. **WARNING:** For applications using clamps with serrated gripping sur-

---

**faces on finished or polished plates, secure written recommendations from RENFROE.**

**STRUCTURAL MEMBERS—FABRICATED SECTIONS:** Unless otherwise specified, clamps described as capable of handling structural members and fabricated sections are limited to hot-rolled steel whose Brinell Hardness does not exceed 300. **WARNING: For applications not covered by the above information, secure written recommendations from RENFROE.**

**RATED CAPACITY:** The rated capacity of a RENFROE product is based on the product being in “new or as new” condition and represents the maximum load the product is to be subjected to when utilized in the manner described in this manual. Wear, misuse, abuse and other factors relating to usage may reduce the rated capacity. Shock loading and the factors listed must be taken into consideration when selecting a RENFROE product for a given application.

**PLATE THICKNESS:** The minimum and maximum plate thickness a clamp specified for handling plates is capable of lifting. **WARNING: Never use a clamp for lifting a plate where the plate thickness is less than or greater than the minimum and maximum stenciled on the clamp.**

**JAW OPENING:** The minimum and maximum thickness of a member of clamp specified as having a JAW OPENING is capable of handling. **WARNING: Never use a clamp on a member whose thickness is less than or greater than the range of jaw**

**opening stenciled on the clamp.**

**OPERATING TEMPERATURES:** Unless specified under the Application Section of the individual model, the approved operating temperature of RENFROE clamps is from zero degrees Fahrenheit (-18 Celsius) to a maximum of 200 degrees Fahrenheit (+93 degrees Celsius). The minimum and maximum temperatures apply to both ambient and the material being handled by the clamp. **WARNING: Secure written authorization from RENFROE before using clamps in temperatures other than shown.**

**“HOT LIFTS”:** The Model R and S clamps are available in modifications that are capable of making lifts where the temperatures of the member being lifted exceeds 200 degrees Fahrenheit (+93 degrees Celsius). Depending on conditions a lift may exceed 1000 degrees Fahrenheit (538 degrees Celsius). The exact application and temperatures of the plates to be handled are critical in selecting the proper model. **WARNING: Secure written instructions from RENFROE for all hot lift applications.**

**LOCKING CLAMPS:** Locking clamps are divided into the categories listed below. With the exception of the “Locking Wedge” and “Locking Screw” type the purpose of the locks are to facilitate the attaching and removing of the clamp from the member being handled.

**“LOCK CLOSED”** - an overcenter spring loaded mechanism in which the spring exerts a force on the gripping cam when the lock handle is moved to the “Lock Closed” position. When the

---

handle is moved to unlocked position the force exerted by the spring is relaxed and the gripping cam may be retracted by pushing the lifting shackle into body of clamp. Refer to the Operation Section of specific models of “Lock Closed” clamps for additional details. Typical “Lock Closed” clamps are Models DG, FR and M.

“LOCK OPEN ONLY” - normally used on “Hot Lift” clamps and consists of a manually operated “Lock Stop Pin” that is inserted when gripping cam of clamp is retracted and removed when clamp is positioned on the plate. Tag line may be used to permit operator to remove pin from a greater distance from clamp. Refer to the Operation Section of specific model of “Lock Open Only” clamps for additional details. Typical “Lock Open Only” clamp is the Model RO.

“LOCK OPEN-LOCK CLOSED” - an over-center spring loaded mechanism in which the spring exerts a force on the gripping cam when the lock handle is moved to the “Lock Closed” position. When the handle is moved to the “Lock Open” the gripping cam is maintained in the retracted position for ease in installing the clamp on a plate or member. The Model FRD contains individual “Lock Open” and “Lock Closed” mechanisms that must be operated separately. Refer to the Operation Section of specific models of the “Lock Open-Lock Closed” clamps for additional details. Typical “Lock Open-Lock Closed” clamps are Models FRD, R, S, SD, SEA, SX, TL, TLA and the J-Series.

“LOCKING WEDGE” - is a fluted steel wedge that is driven in place with a

hammer. The body of the wedge is positioned in a slot in the clamp body with the fluted edges contacting the member to which the clamp is being attached. Refer to Operation Section of specific models of the “Locking Wedge” clamps for additional details. Typical “Locking Wedge” clamps are Model A1, B1, B2 and PB.

“LOCKING SCREW” - “Lock Screw” clamps depend on manually adjusting a screw to hold the gripping surface in place for lifting and removing the clamp from member being lifted. Refer to Operation Section of a specific model of “Locking Screw” clamps for additional details. Typical “Locking Screw” clamps are Models AC, ACP, NM, PC, SCP and SCPA.

NON-LOCKING: “Non-Locking” clamps have no mechanisms to aid in attaching or removing clamp from member being lifted. It is necessary to have position of clamp maintained on the member being lifted until a properly applied force is exerted to the lifting shackle. Refer to Operation Section of specific models of the “Non-Locking” clamps for additional details. Typical “Non-Locking” clamps are Model AST, ASTL, BD, HR, HDR and WHSR.

**WARNING:** A pointing out and notice of danger. The purpose of a “WARNING” is to apprise the operator and all other affected persons of the existence of danger of which he should be but may not be aware and to enable the operator to protect himself and others where applicable against such danger. An attempt is made herein to warn against reasonable and reasonably foreseeable danger in the proper use and possible reasonable misuse of RENFROE products described in this manual.



---

**DESIGNATED PERSON** — A person selected by the employer or the employer's representative as being competent to perform those specific duties.

**QUALIFIED PERSON** — A person who, by possession of a recognized degree in an applicable field or certificate of professional standing, or who, by extensive knowledge, training, and experience, has successfully demonstrated the ability to solve problems relating to the subject matter at hand.

---

## MODEL DWS

### HORIZONTAL LIFTING LOCKING CLAMP



### APPLICATION

The Model DWS is a horizontal lifting clamp intended to be used in pairs, sets of pairs, or in a tripod arrangement for transporting plate horizontally. Refer to Illustrations A, B and C. The Model DWS incorporates a “Lock Closed” feature which facilitates attaching the clamp to the member being lifted and make it an ideal horizontal locking plate clamp. Refer to definition pages for explanation of “Lock Closed” clamp.

For identification of component parts, refer to the exploded view of the clamp located at the end of the Maintenance Section.

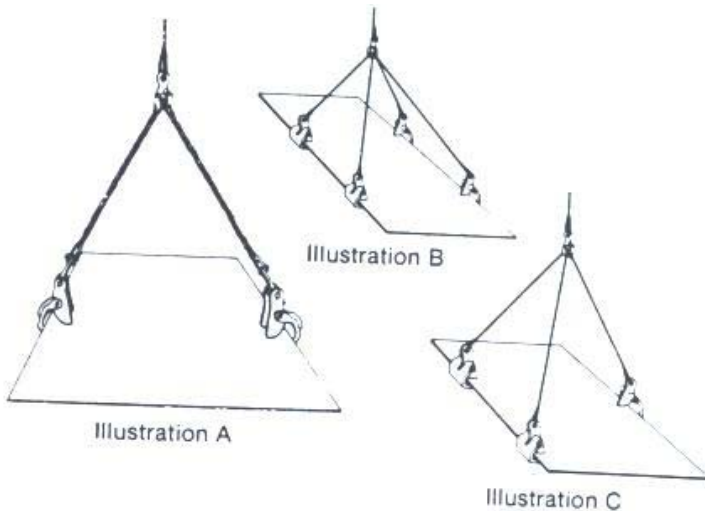

---

**WARNING:** The rated capacity is based on a sling angle of 60 degrees. Refer to Illustration D. Sling angles less than 60 degrees increases load on the clamps. Refer to Operation Section, Step 3, Chart E, for corrected loading of clamp with sling angles less than 60 degrees. Always use an adequate number of clamps to assure a balanced load. Never exceed the rated capacity of a single clamp. Never use on a plate or a bundle of plates that are not able to support themselves without sagging. Refer to Illustration D.

**WARNING:** Refer to the section on Operation and Maintenance for the approved procedures in the Operation and Maintenance of this product.



## **OPERATION**

### Step 1.

Before using any RENFROE clamp, refer to the Application Section to confirm the operation to be undertaken is appropriate for the product.

### Step 2.

Select appropriate capacity and jaw opening. The model designation, capacity and jaw opening are stenciled on each clamp. Use of sling angles under 60 degrees decreases the rated capacity. Refer to Chart E.

**WARNING:** Never exceed rated capacity or use on material whose thickness is not within the range of jaw opening stenciled on clamp.

**Always use clamps with maximum jaw opening and rated capacity near or equal to the thickness and weight of the section being lifted.**

**Always use clamps with maximum jaw opening and rated capacity near or equal to the thickness and weight of the section being lifted.**

**CHART E**

**RATED CAPACITY IN TONS**

Model/ Capacity	Sling Angles		
	60°	45°	30°
DWS 1/2 Ton	0.5	0.35	0.25
DWS 1 1/2 Ton	1.5	1.05	0.75
DWS 3 Ton	3.0	2.1	1.5

**WARNING:** Always use an adequate number of clamps to assure a balanced load. Never use on plate or bundle of plates that are not able to support themselves without sagging or stacked without edge being even. Refer to Illustration D and F.

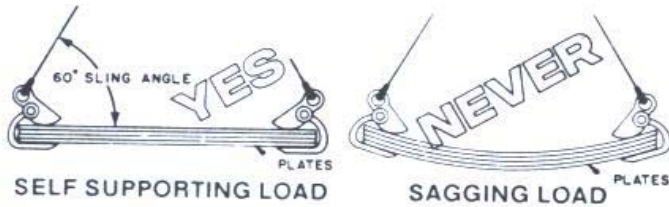

Illustration D

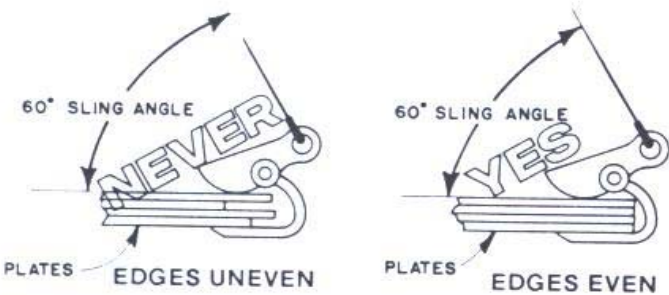

Illustration F

---

Step 3.

Inspect clamp before each lift.

**WARNING: Do not use if in need of repair. If in doubt, refer to Maintenance Section for detailed maintenance instructions and exploded view of the clamp for part identification.**

- A. Check the clamp to be certain the Identification and warning tags are present and legible.
- B. Do not use the clamp if the tags are missing or illegible
- C. Inspect gripping surfaces for wear and defects. Gripping surfaces must be sharp and free of foreign matter.
- D. Inspect condition of body for wear, damage and distortion, particularly in the area of the jaw opening.
- E. Inspect lifting shackle and all pin holes for wear and damage.
- F. Lock spring must have a definite amount of tension when lock is moved to the “Lock Closed” position without material in the clamp.
- G. Remove any clamp from service in need of repair.

Step 4.

A clamp is a component of the rigging used in lifting or transporting a member. It is important to use safe and adequate rigging. The lock is used to hold the clamp in place until the gripping mechanism is actuated by a force applied to the lifting shackle.

**WARNING: Improper or excessively heavy rigging may interfere with the operation of the clamp and its ability to maintain a proper position on the plate. Never attach crane hook directly to the clamp - always use a flexible sling between crane hook and clamp.**

---

Step 5.  
Move lock to “Open” position. Refer to Illustration A.

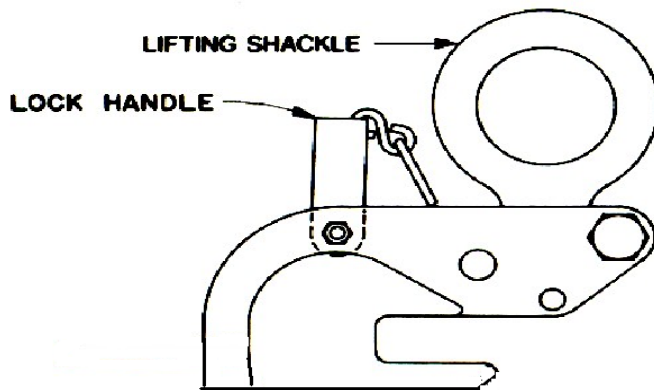

## **“OPEN” POSITION**

Illustration A

Step 6.  
Position clamp on member to be lifted.

---

## Step 7

Position clamp so direction of force applied by the crane is in line with the lifting shackle.

**WARNING: Never exceed ten degree side-loading.**

Refer to Photographs C, D and E.

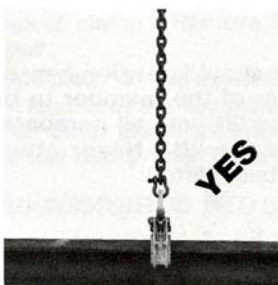

Photograph C Sling directly above and in line with lifting shackle.

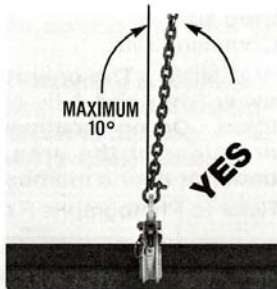

Photograph D Maximum allowable sideloading.



Photograph E Excessive sideloading.

## Step 8.

Make certain the lower jaw and gripping cam are fully in contact with the member being lifted, and not partially on and off the edge of the member.

---

Step 9.

Place the lock lever in “Lock Closed” position. Lock handle body must rest on body spacer. Spring now exerts force on gripping cam. Refer to Illustration B.

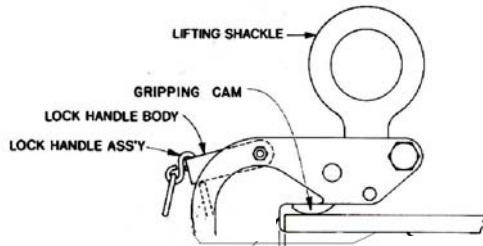

“LOCK CLOSED” POSITION

Illustration B

Step 10.

Commence lift.

**WARNING:** The operator should position himself away from and fully clear of the member to be lifted. Do not commence lift until all personnel are clear of the area of the lift. Never stand under or near a member being lifted.

Refer to photograph G.



Photograph G



---

Step 11.

To remove clamp - after member is fully supported and at rest in a stable position, relax lifting force, move lock handle to “Open” position, lift clamp from member

Step 12.

Inspect clamp. Remove from service if in need or repair.

**WARNING: In the event the stenciling is worn and not legible or the tag containing the model, capacity or other pertinent information is missing - do not use clamp until it has been properly labeled.**

Inspection Kits are available at no charge upon request from the distributor or RENFROE.

Kit contains:



---

## **Maintenance Program for Renfroe Clamps Manufactured from Steel**

The severity of service to which the clamp is subjected in the work place determines the frequency and type of inspection procedure required for the clamp. The frequency and type of inspection is determined by the clamp owner. Renfroe acknowledges the ASME B30.20 safety standard which sets forth minimum inspection requirements for “Below-the-Hook” lifting devices and the Renfroe Recommended Inspection Schedule meets and/or exceeds the ASME inspection recommendations.

**Before using a clamp operators should be trained by a qualified person to visually inspect a lifting clamp that will include but not be limited to the following:**

### **Every lift Inspection:**

*A visual inspection by the operator before and after each lift made by the clamp.*

- Check the clamp to be certain the Identification and warning tags are present and legible.
- Do not use the clamp if the tags are missing or illegible
- Inspect gripping surfaces for wear and defects. Gripping surfaces must be sharp and free of foreign matter.
- Inspect condition of body for wear, damage and distortion, particularly in the area of the jaw opening.
- Inspect lifting shackle and all pin holes for wear and damage.
- Lock spring must have a definite amount of tension when lock is moved to the “Lock Closed” position without material in the clamp.
- Remove any clamp from service in need of repair.

---

**WARNING: Do not use the clamp if in need of repair.**

If, during the every lift inspection, the operator believes the clamp exhibits excessively worn parts or is damaged, the clamp should be inspected by a qualified person who will make a determination as to its fitness to make a lift. At this time the condition of the clamp should be noted and recorded. After inspection by the qualified person it may be decided that a periodic inspection procedure is necessary.

**Frequent Inspection:**

*A visual inspection (see every lift inspection) by an operator or other designated person timed according to the clamps service class.*

- **Normal Service:** monthly
- **Heavy Service:** weekly to monthly
- **Severe Service:** daily to weekly.

If, during the frequent lift inspection, the operator believes the clamp exhibits excessively worn parts or is damaged the clamp should be inspected by a qualified person who will make a determination as to its fitness to make a lift. At this time the condition of the clamp should be noted and recorded. After inspection by the qualified person, it may be decided that a periodic inspection procedure is necessary.

**Periodic Inspection:**

*A recorded inspection by a qualified person as described in the Periodic Inspection Procedure below timed according to the clamps service class.*

- **Normal Service:** annual
- **Heavy Service:** semi-annual
- **Severe Service:** quarterly.

If during any inspection a condition is found which leads to a periodic inspection then the next periodic inspection is due from the time the clamp is returned to service. For example under a Normal Service schedule, one year from the time the clamp is returned to service.

**Renfroe recommends that a periodic inspection be conducted if any hazardous condition is found.**

---

**Warning: If any hazardous condition is found that may cause injury to the operator or other personnel then the clamp should be subjected to a Periodic Inspection by a Qualified Person.**

**Repair (replacement of worn parts)**

During regular maintenance when replacing parts that are worn a record should be made of the parts replaced. After the replacement of worn parts clamps need not be load tested.

**Repair (replacement of damaged parts)**

During a repair in which parts are replaced due to damage a record should be made of the repair. At this time the clamp should be marked with the following information as per the ASME B30.20 requirements:

- **Name and address of the repairer**
- **Repairer's unit identification**
- **Clamp weight (if altered)**
- **Rated load (if altered)**
- **ASME BTH-1 Design Category (if altered)**
- **ASME BTH-1 Service Class (if altered)**

RENFROE clamps are constructed so the wearing parts may be replaced by installing individual parts or using RENFROE Repair Kits containing all parts generally replaced due to normal wear.

---

## **Model DWS PERIODIC INSPECTION PROCEDURES**

Step 1. Verify the identity of the clamp by checking the I. D. plate on the clamp body. If the I. D. plate is missing or not legible an RFID chip (Radio Frequency Identification Device) is embedded either in the clamp body or a clamp component. If the I. D. plate is missing and the RFID chip is unavailable call the Renfro factory for instructions on returning the clamp for recertification.

Step 2.

Completely disassemble clamp.

Step 3

.Remove all dirt, grease and other matter that may inhibit proper inspection of the clamp body or clamp components.

Step 4. Body - Inspect welds for fractures. RENFROE recommends a dye penetrant or similar method of detecting indications on the clamp. If an indication is found it may be necessary to use a magnetic particle, ultrasonic or similar methods for determining damage to the clamp or components.

A. Inspect all pin holes for wear and elongation.

B. Inspect inside area of jaw opening for displaced metal and distortion.

C. Inspect cam stop pin - pin must be in place. Refer to exploded view.

**WARNING: Replace clamps containing fractures, elongated holes, distorted jaw openings and clamp bodies with metal in jaw opening displaced. Cam stop pin must be in place.**

Step 5.

Gripping Cam - DWS-1

A. Inspect gripping cam for chipped or worn teeth. Teeth must be sharp and free of foreign matter.

**B.** Inspect cam for fractures and wear.

**WARNING: Replace cams with fractures, chipped or worn teeth.**

Step 6.Lifting Shackle - DWS-2

A. Inspect lifting shackle eye for elongation and wear at point where eye engages sling attachment.

B. Inspect shackle pin holes for wear and elongation.

C. Inspect shackle body for bending.

Elongated shackle eye indicates overloading. Elongated shackle pin holes indicate wear and possible overloading. Bent shackles indicate excessive side-loading.

**WARNING: Replace shackles that are bent, show excessive wear at eye and have elongated eye or shackle pin holes.**

Step 7.

Lock Assembly and Lock Ring - DWS-3 & DWS-10

- A. Inspect for damage and wear. Lock assembly should pivot freely without binding. When assembling lock body to clamp, tighten pivot screw lock nuts, then loosen until lock body pivots freely.
- B. Make certain locking ring is attached.

**WARNING: Do not alter lock assembly. Use only component parts supplied by RENFROE. Replace worn or damaged parts.**

Step 8.

Lock Spring and Spring Clip - DWS-4 & DWS-8

- A. Inspect lock spring and lock spring clip for distortion. Spring should have a definite amount of tension when moved to the “Lock Closed” position without material in the clamp. Lock handle body must rest on body spacer. Refer to Illustration J. **WARNING: Replace if damaged, distorted or locking in tension.**
- B. The spring clip mounts on a spiral pin passing through the gripping cam and through the end loop of the lock spring. Check to make certain the spiral pin and loop are not damaged or distorted. Refer to exploded view. **WARNING: Replace if damaged or distorted.**

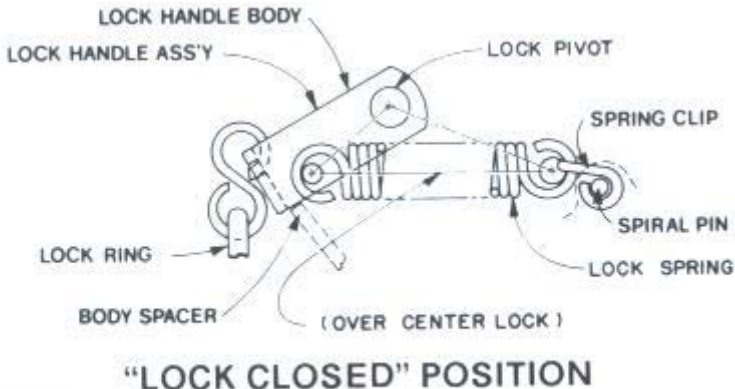

Illustration J

---

Step 9.

Shackle Pin and Cam Pin - DWS-5 & DWS-6

- A. Inspect all pins for:
1. Distortion
  2. Surface blemishes
  3. Wear
  4. Fractures

**WARNING: Replace pins that are distorted, have surface scars, are worn and contain fractures.**

Step 10.

Body Bolt and Spacer Sleeve - DWS-7

- A. Inspect body bolt and spacer sleeve for wear at position where shackle contacts sleeve.
- B. Inspect body bolt.
- C. Make certain that body bolt nut is tight. In replacing body bolt, tighten bolt and nut, then center-punch bolt and nut at thread to lock nut in place.

**WARNING: Replace body bolt, nut and sleeve if worn or damaged.**

Step 11.

Assembly

After reassembly, check operation of clamp. All parts should move freely without binding. Refer to exploded view for proper location of component parts.

**WARNING: All retaining pins and fasteners must be in place.**

**WARNING: Do not weld, grind or modify the clamp body or component parts in any manner. In the event the stenciling is worn and not legible or the tag containing the model, capacity or other pertinent information is missing - do not use clamp until it has been properly labeled.**

GENERAL

RENFROE products may be returned to the factory for inspection and refurbishment in accordance with an established fee schedule.

Use only RENFROE replacement parts to insure maximum efficiency and safety factor originally built into the product. Refer to RENFROE catalog for instructions on ordering replacement parts.

**Warning: The clamp must not be returned to service until any hazardous conditions found in any inspections are corrected.**

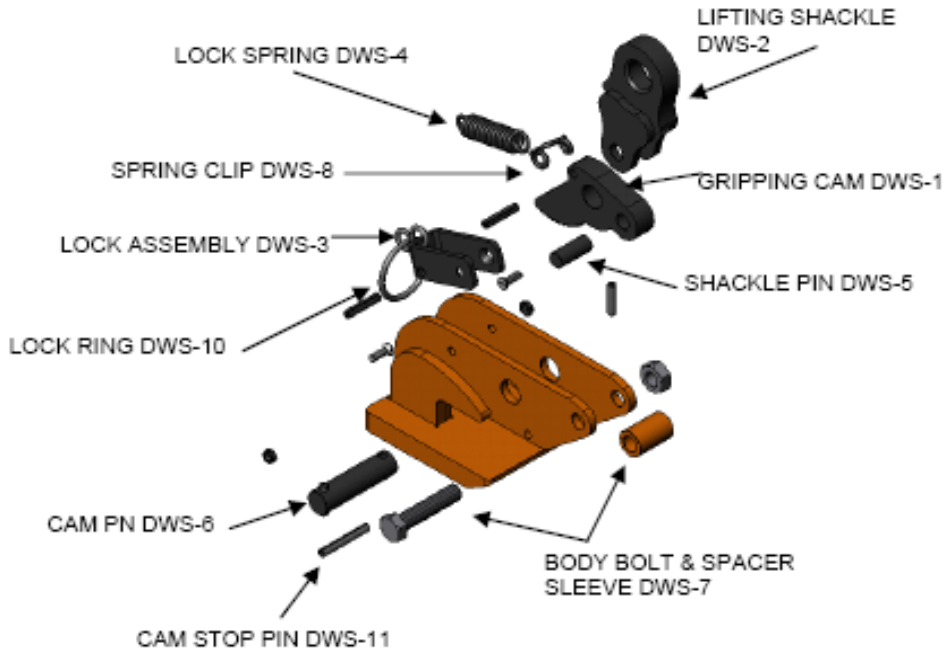

### **EXCLUSION OF WARRANTY**

**THERE EXISTS NO WARRANTIES NEITHER EXPRESSED NOR IMPLIED WHICH EXTEND BEYOND THE DESCRIPTIONS OR STATEMENTS CONTAINED IN THE FACE OR ANY PART HEREOF.**



# **J.C. RENFROE & SONS, INC.**

P.O. Box 4279 • 1926 Spearing Street • Jacksonville, Florida 32206  
Phone: U.S.A. Toll Free (800) 874-8454 - 904/356-4181  
Facsimile: 904/354-7865 • Internet: [www.jcrenfroe.com](http://www.jcrenfroe.com)